

270 Horizontal Slider Component Identification

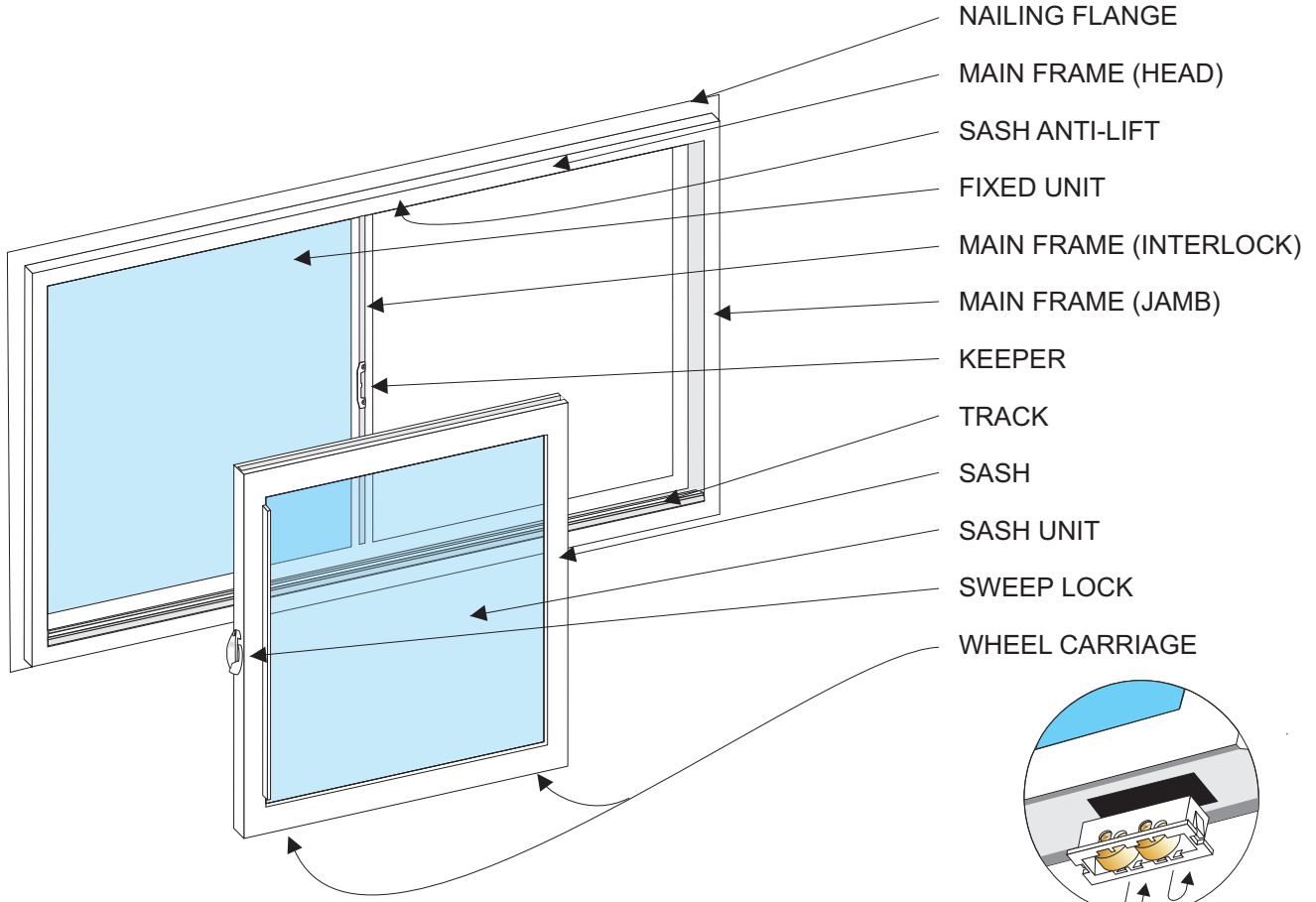

- NAILING FLANGE
- MAIN FRAME (HEAD)
- SASH ANTI-LIFT
- FIXED UNIT
- MAIN FRAME (INTERLOCK)
- MAIN FRAME (JAMB)
- KEEPER
- TRACK
- SASH
- SASH UNIT
- SWEEP LOCK
- WHEEL CARRIAGE

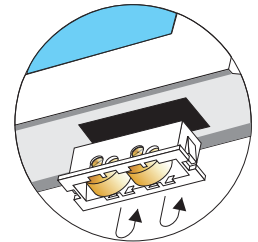

WHEEL CARRIAGE
w/ adjustable brass rollers

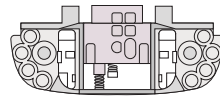

Positive Action Lock

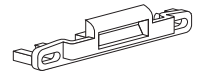

P.A.L. 70 SERIES KEEPER



SWEEP LOCK

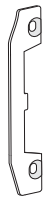

KEEPER

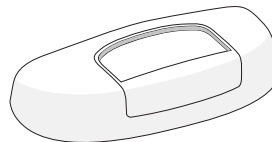

P.A.L. LOCK COVER

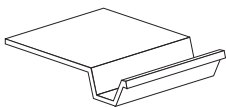

SASH ANTI-LIFT



WEEP HOLE COVER

Horizontal Slider Maintenance

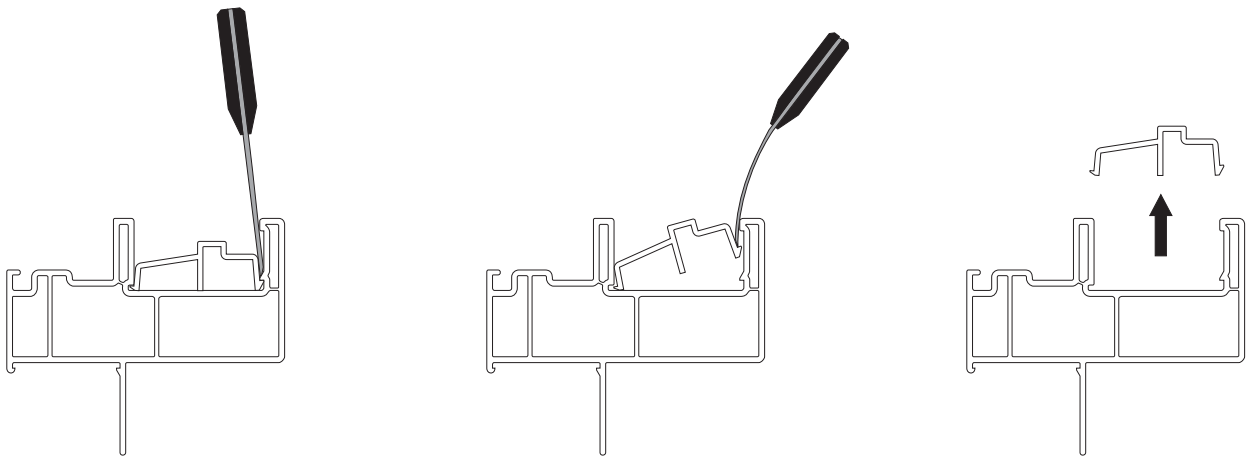

Maintaining the window will involve cleaning the frame and track. To flush the weep system, remove the sliding vent sash. Open the sash completely, clearing the "anti-lift" located in the head, lift sash and swing bottom inward.

To remove the track, insert a stiff putty knife or prying tool between the track and main frame (illustrated above). Pry the track up and out of the channel.

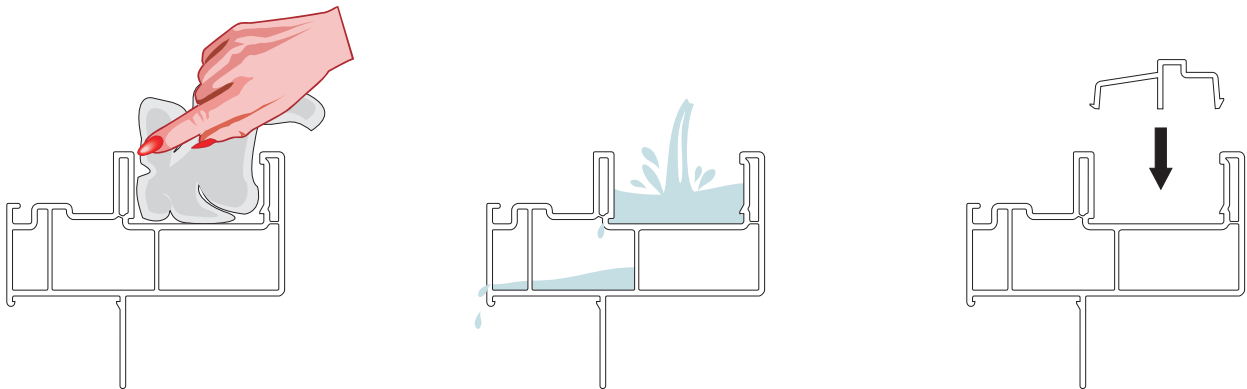

Remove debris and wash the frame and track channel with warm soapy water. Flush the weep system by pouring clean water into the sill track channel. The water should drain freely out of the exterior weep holes.

When reinstalling the track, make sure it is located in the correct direction and is securely locked down into the main frame sill.

270 Horizontal Slider Parts List

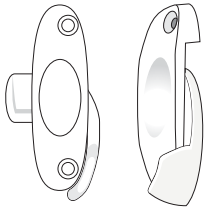

**SWEEP LOCK
RIGHT(XO)**
WHITE - 111-103-WH
BH218701
ALMOND - 111-103-BE
BH218754
CLAY - 110-0155
BH218751

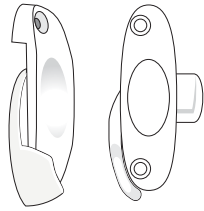

**SWEEP LOCK
LEFT (OX)**
WHITE - 111-103L-WH
BH218601
ALMOND - 111-103L-BE
BH218654
CLAY - 110-0154
BH218651

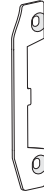

KEEPER
WHITE - 111-118-WH
BH219001
ALMOND - 111-118-BE
BH219054
CLAY - 110-0156
BH219051

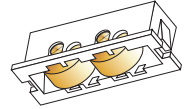

**WHEEL CARRIAGE
(SNAP HOUSING &
ROLLER ASSM.)**
111-120
BH177600

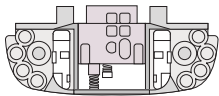

P.A.L. LOCK
UM001500

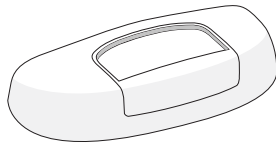

P.A.L. LOCK COVER
WHITE - UM001801
CLAY - UM001851
ALMOND - UM001854



**111-1218
WEEP HOLE COVER**
WHITE - BH177301
ALMOND - BH177354
CLAY - BH177351

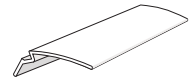

GLAZING BEAD 156"
WHITE - BC617701
ALMOND - BC617754
CLAY - BC617751

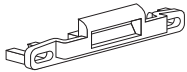

P.A.L. 70 SERIES KEEPER
WHITE - BH305001
CLAY - BH305051
ALMOND - BH305054

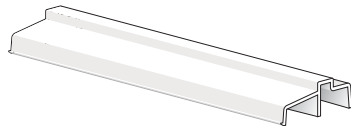

270 SASH TRACK
WHITE - BC653801
ALMOND - BC653854
CLAY - BC653851

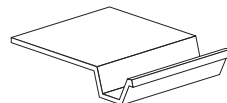

**6539
VENT ANTI-LIFT**
WHITE - BC653901
ALMOND - BC653954
CLAY - BC653951

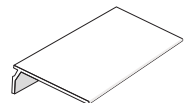

**6373
SINGLE GLAZING BEAD**
WHITE - BC637301
ALMOND - BC637354
CLAY - BC637551

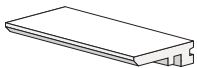

**6554
SETTING BLOCK
(FIXED)**
BC655401



**ADHESIVE
SETTING BLOCK**
13/16"x13/16"x1/8"
UM010700

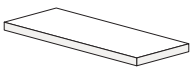

**6166
SETTING BLOCK
(SASH)**
BC616601

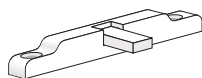

**FRESH-AIR STOP
HOUSING - BOLT**
WHITE - BH305400 - BH107701
ALMOND - BH305454 - BH107754
CLAY - BH305151 - BH107751

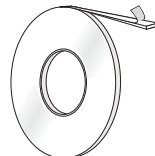

GLAZING TAPE
1/16" x 3/8"
GRAY, ACRY
US079210



**FLEXIBLE - RADIUS
GLAZING BEAD**
WHITE - BH157701
ALMOND - BH157754
CLAY - BH157751



FRAME INTERLOCK SCREW
W/ rubber washer
8X212.TR.SQ.SS.18-8
BF156000



SWEEP LOCK SCREW
CAM LOCK SCREW
KEEPER SCREW
#6x3/4" Phil,Flat,Tek
WHITE - BF207501
ALMOND - BF207554
CLAY - BF207551



HOLE PLUG
WHITE - BH286301
ALMOND - BH286354
CLAY - BH286351



PAL KEEPER SCREW
#6x3/4" Phil,Pan,Tek
WHITE - BF208001
ALMOND - BF208054
CLAY - BF208051



VENTILATOR SCREW
6x5/8" Phil,Pan,SS
WHITE - BF207900
ALMOND - BF207954
CLAY - BF207951



CLIP FOAM PLUG
1/4x1/4x3/4, WHITE
BH245401

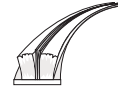

FIN-SEAL
WEATHERSTRIPPING
W232317
BH176801

270 Extrusions

Reinforcement for XOX
BM193200

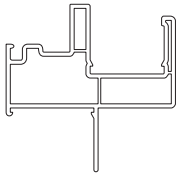

7351
STANDARD 1 3/8
WHITE - BV735101
ALMOND - BV735154
CLAY - BV735151

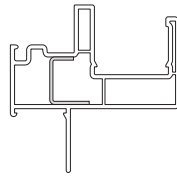

7819
7/8 NAIL FIN
WHITE - BV781901
ALMOND - BV781954
CLAY - BV781951

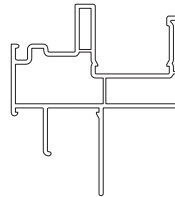

7357
INTEGRAL J CHANNEL
WHITE - BV735701
ALMOND - BV735754
CLAY - BV735751

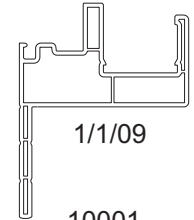

10001
STUCCO (FLUSH FIN)
WHITE - BV100101
ALMOND - BV100154
CLAY - BV100151

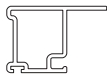

7354
SASH STILE
WHITE - BV735401
ALMOND - BV735454
CLAY - BV735451

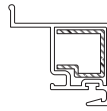

7353
SASH INTERLOCK
WHITE - BV735301
ALMOND - BV735354
CLAY - BV735351
REINFORCEMENT
BM194800

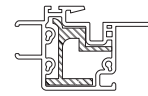

7820
FIXED INTERLOCK
WHITE - BV782001
ALMOND - BV782054
CLAY - BV782051
REINFORCEMENT
BM194700

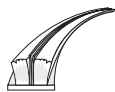

FIN-SEAL
WEATHERSTRIPPING
W232317
BH176801



DP FILLER
WHITE - BC683001
ALMOND - BC683054
CLAY - BC683051

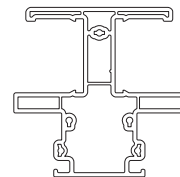

7367
DUAL POCKET BAR
WHITE - BV736701
ALMOND - BV736754
CLAY - BV736751

270 / 570 Series Window Screen

